

**Intended use**

Safety Edges are used for protecting against risks at shearing and crushing edges, for instance at machine guards, lifting tables, packaging machines, palletizing and depalletizing systems, automated guided vehicles (AGV's), theater stages and many others. They can be used in indoor and outdoor applications.

All Safety Edges of series HSC® meet the requirements for safety components according to the Machinery Directive 2006/42/EC.

**Please note:** When using cooling agents, oils, acids etc. please contact manufacturer for more information.

**Function**

Except for dimensions and shapes, the Safety Edges have a generally identical design. They contain the following components:

- Haake Safety Contact chain® HSC® (N/C contacts)
- Aluminium profiles for mounting the sensor part at the machine body
- Double-insulated connection cables to the machine control system
- TPE hollow-chamber profile and closure plugs

Upon actuation of the Safety Edge (sensor), the current flow is interrupted, based on the special geometry of the chain links inside the sensor. This interruption represents the OFF condition of the output signal switching device and thus transfers the safety output signal to the machine control system.

The Safety Edge meets the requirements for automatic reset, since after removing the operating force, it will return by itself into the ON condition.

If it is required to work with a manual reset, this has to be implemented according to DIN EN ISO13856-2 by the machine control system.

Due to the positive break of the supply (current circuit is broken), a separate safety control unit is not required. Safety Edge and control system together have to achieve the Performance Level that has been determined in the risk assessment.

**Technical data**

Operating temperature:	-20 ... +55 °C
Enclosure sealing:	IP65
Nominal voltage:	<50 V AC, 75 V DC <small>(with safe separation from the supply system) A voltage source for SELV or PELV systems according to DIN VDE 0100-410 shall be used.</small>
Nominal current:	max. 0,5 A, AC/DC <small>The power supply shall be protected externally (fuse 0.5 A nominal value)!</small>
Control category:	3 (to DIN EN ISO 13849-1)
Performance Level:	Possible up to d
Connection cable:	double-insulated, highly flexible single-core cables (FLKM)
Connection cable length:	max. 50 m
Safety Edge length:	max. 6 m (single unit)
Material of sensor:	TPE
Material of profile:	Aluminium

**Force-travel-diagram**

$SG = SB + SN$   
 $SB = 5.2 \text{ mm}$   
 $SN = 8.3 \text{ mm}$   
 $SG = 5.2 \text{ mm} + 8.3 \text{ mm}$   
 $SG = 13.5 \text{ mm}$   
 Actuating force  $F = 82 \text{ N}$   
 A: Switching point  
 SG: Total deformation  
 SB: Actuating travel  
 SN: Overtravel

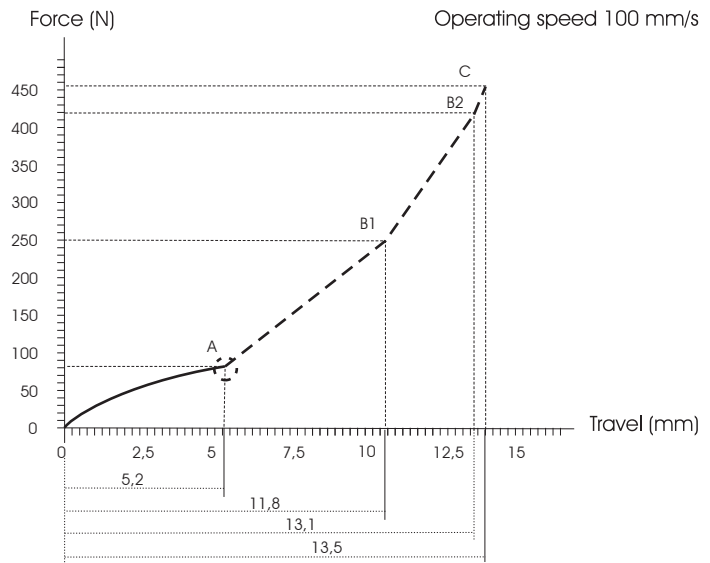

**Distance dimensions** (see also request form on page 3)

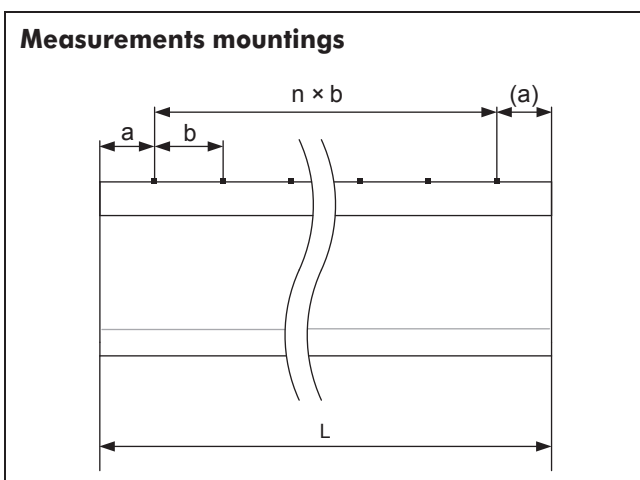
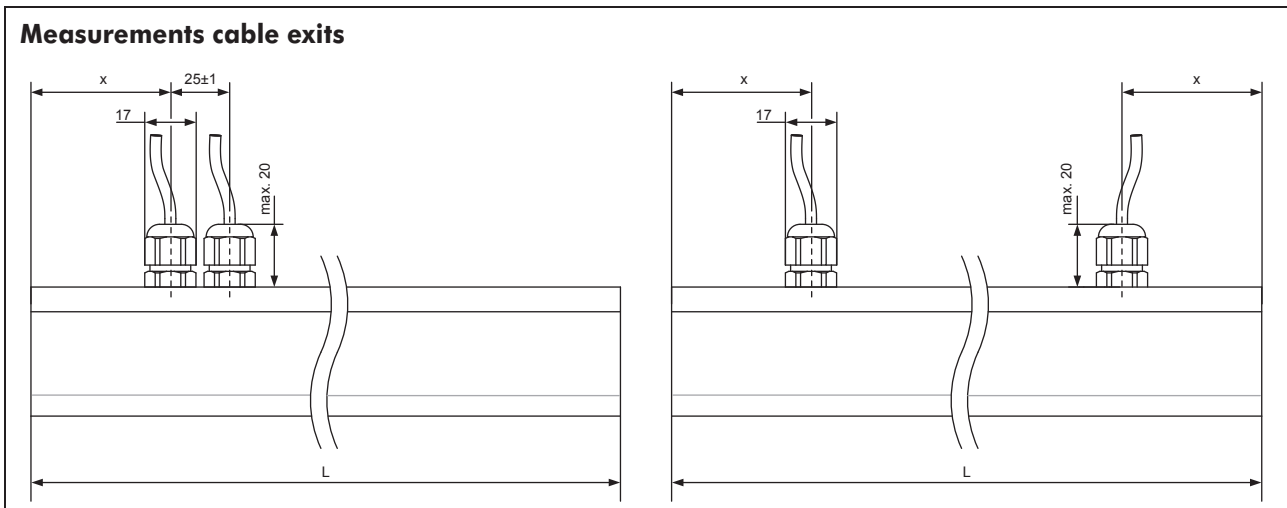

General tolerances ISO 2768-m



**Inquiry**

First and last name		E-Mail:	
Company:			
Street and no.:			
Postal code/ZIP and city:		Country:	
Phone no.:		Fax no.:	

**Length and application**

Length: _____ mm	Application:	<input type="checkbox"/> Indoor dry	<input type="checkbox"/> Indoor medium	<input type="checkbox"/> Outdoor wet
------------------	--------------	-------------------------------------	--	--------------------------------------

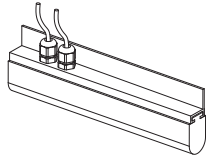
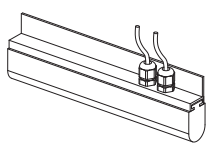
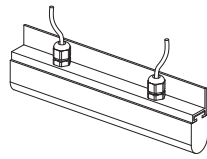
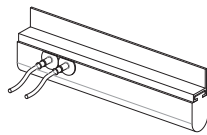
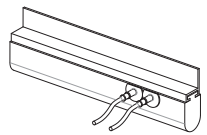
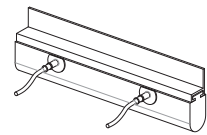
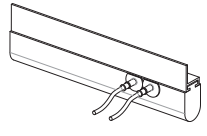
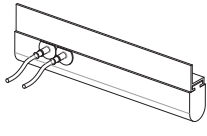
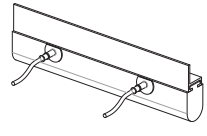
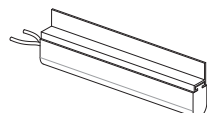
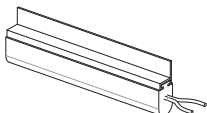
**Type and position of cable exit** (see also Distance dimensions on page 2)

Top			
<input type="checkbox"/>  Top left, x = 50 mm	<input type="checkbox"/>  Top right, x = 50 mm	<input type="checkbox"/>  Top left and right, x = 50 mm	
At side			
<input type="checkbox"/>  Front left, x = 50 mm	<input type="checkbox"/>  Front right, x = 50 mm	<input type="checkbox"/>  Front left and right, x = 50 mm	
<input type="checkbox"/>  Rear left, x = 50 mm	<input type="checkbox"/>  Rear right, x = 50 mm	<input type="checkbox"/>  Rear left and right, x = 50 mm	
Frontal			
<input type="checkbox"/>  Frontal left	<input type="checkbox"/>  Frontal right	<input type="checkbox"/>  Frontal left and right	

**Cable length**

<input type="checkbox"/> 1.000 mm (Standard)	<input type="checkbox"/> _____ mm (Upon request, surcharge)
--	---

**Mounting possibilities**

<input type="checkbox"/> No mounting possibilities (made by client)
<input type="checkbox"/> Boreholes $\varnothing = 6$ mm
<input type="checkbox"/> Oblong holes $7.5 \times 21$ mm

**Dimensions** (see also Distance dimensions on page 2)

Mounting dimensions are specified by variables a and b.	
a is for first and last distances (symmetrical design) and b is for intermediate distances.	
<input type="checkbox"/> Selected by manufacturer	<input type="checkbox"/> Own distances a = ___ b = ___ mm